

BREAK

MACHINERY

Recycling
beyond
together

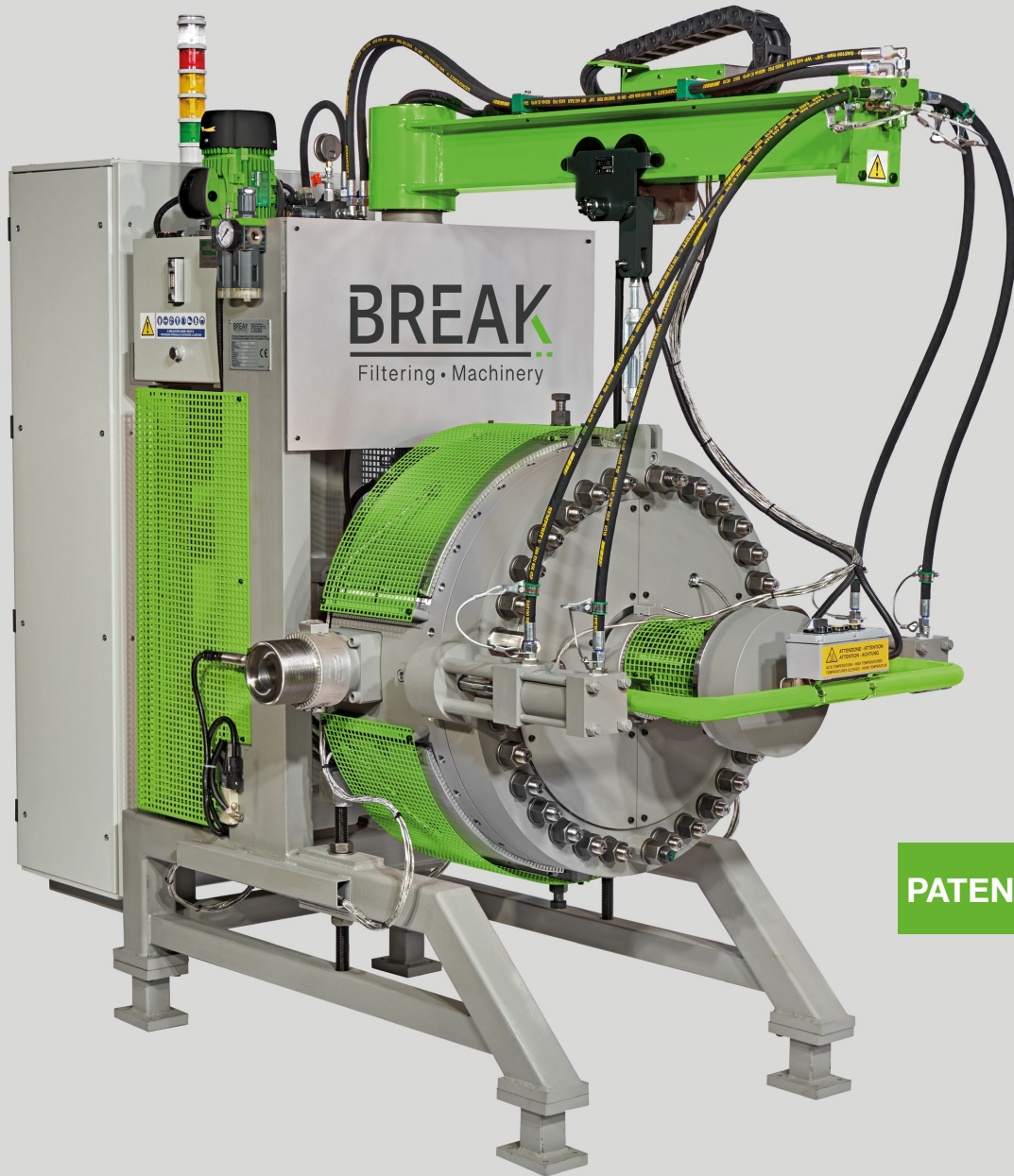

PATENTED

English

Automatic self-cleaning filter system

ONE



breakmachinery.com



Reliability.



Efficiency.



Ease of management.

Quality polymer

Filtration is undoubtedly the most important step in obtaining a quality polymer, which is why **Break Machinery** made this process central in its mission.



ONE is suitable for production lines of: recycling granules, polymerization granules, masterbatch granules and compounds, adhesives (Hot melt), tubular or flat films, thermoforming plates, pipes and profiles, cable covering.

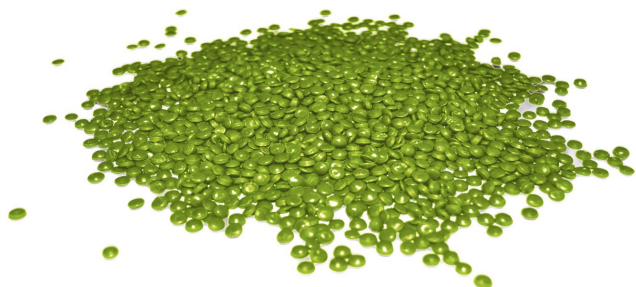

ONE



ONE automatic self-cleaning filter system

ONE was designed to the **highest quality standards** and successfully passed the most stringent production tests on various types of equipment, ensuring **excellent filtration performance**.

The careful study of the mechanisms, materials and filtration chamber is the engineering element that enabled us to achieve our standards.

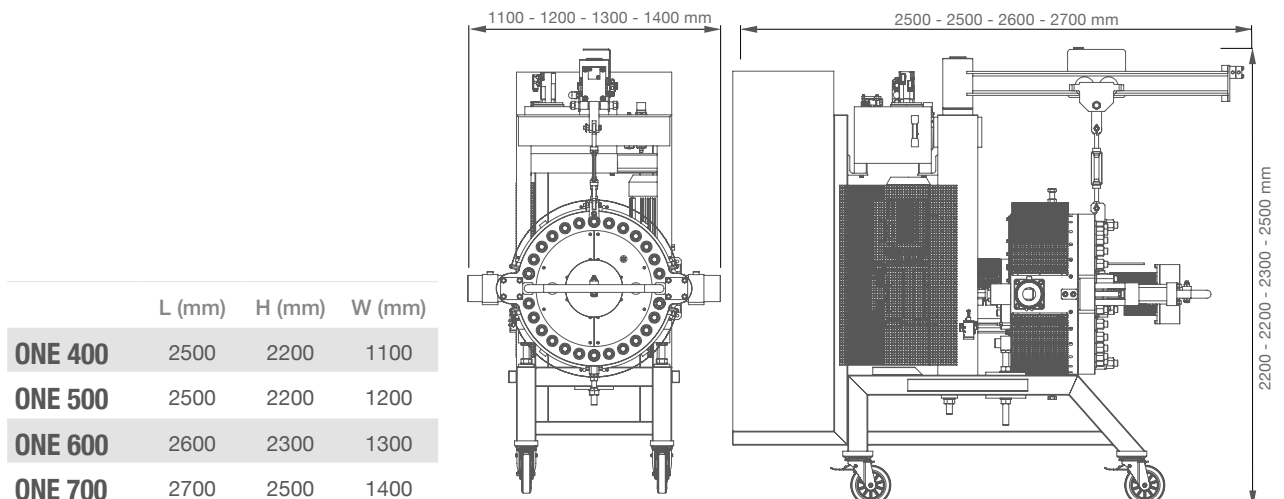

Main Components

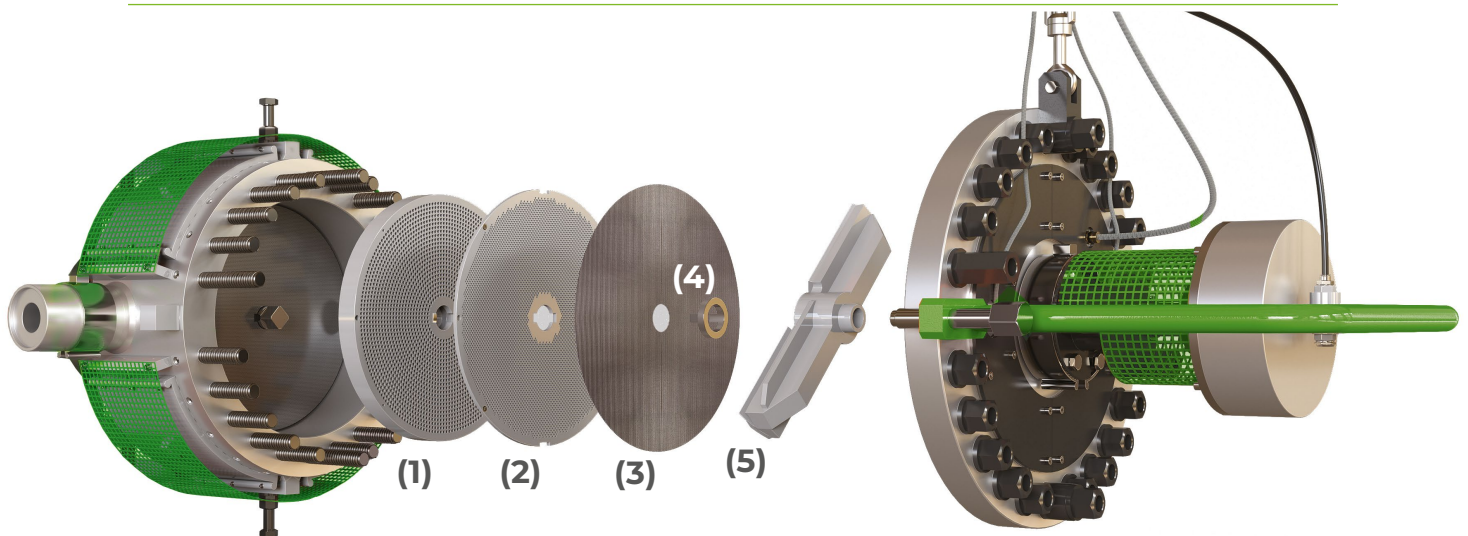

■ (1) Main breaker

■ (2) Secondary breaker

■ (3) Laser or punched screen

■ (4) Spacer

■ (5) Scraper

■ Steel breaker and screen

The scraping operation mode uses a thick steel breaker coupled with a thinner breaker whose purpose is to improve the passage and increase the flow of plastic material, and an interchangeable steel screen (punched or laser micro-perforated) for filtrations from 60 to 2000 microns.

■ Touch screen displays

ONE can be customized with touch screen displays, agreeing with the customer the graphic layout and the desired reading parameters.

■ Spacer and scraper

A spacer allows the scraper blades to work at the right distance from the screen so as not to damage it.

■ Centralised

ONE can be connected with the company's 4.0 communication network.

The machine is prepared for assembly according to the Customer's needs, with inlet and outlet flanges.

Advantages



■ Increased production

Increased production, compared to cassette systems, due to automatic filter cleaning and the absence of traditional interruptions due to screen changes by the operator.

■ Reliability

The manufacturing process, from the design to the choice of materials and to the assembly in our factories, guarantees the highest quality to the product in terms of performance and durability.

■ Simplicity of management

The simplicity and effectiveness of its construction allow for routine and unscheduled maintenance directly at the customer's premises, reducing downtime to a minimum.

■ Productivity

The continuous filtering system maximises line productivity, compared to traditional cassette systems.

■ Saving

The efficiency of the cleaning system in continuous mode results in a longer utilisation of the laser screen, resulting reduction in terms of purchasing consumables.

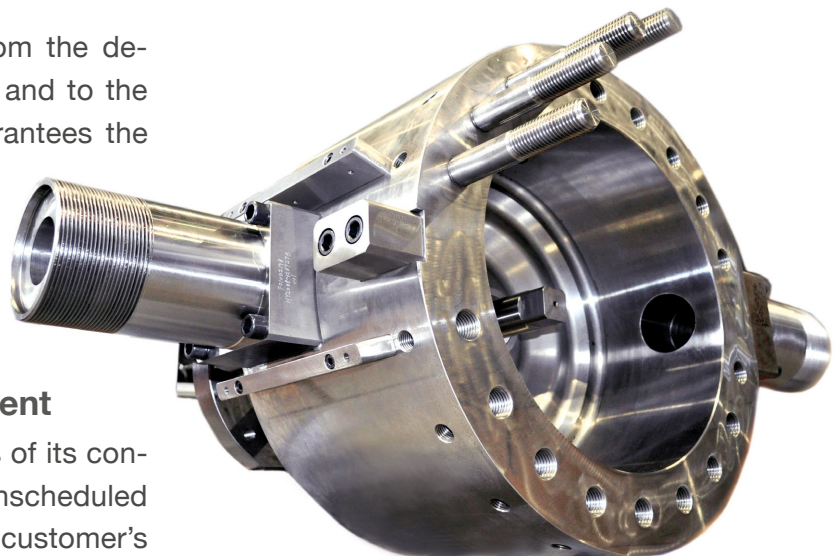

■ Efficiency

Continuous automatic self-cleaning **ONE** filter optimizes the filtration of impurities without affecting the productivity of the line reducing production waste.

Operating principle

ONE: self-cleaning filter system

(1) The extruder pushes the contaminated plastic material into the **ONE** screen changer.

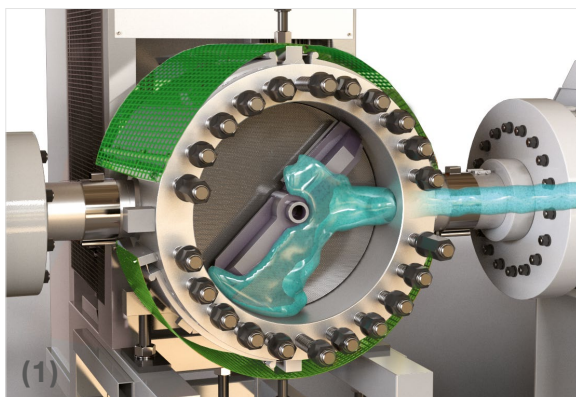

(2) A steel screen punched or laser perforated, with the filter capacity chosen by the customer, removes impurities from the plastic material.

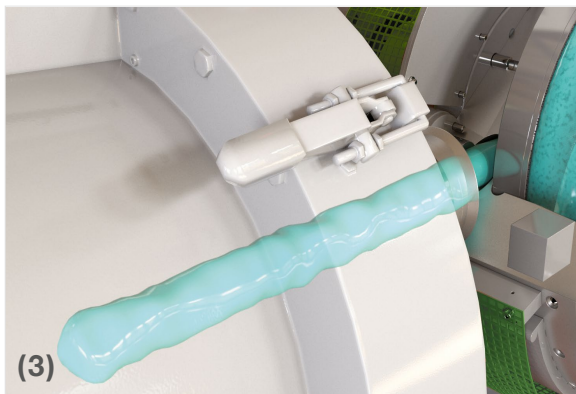
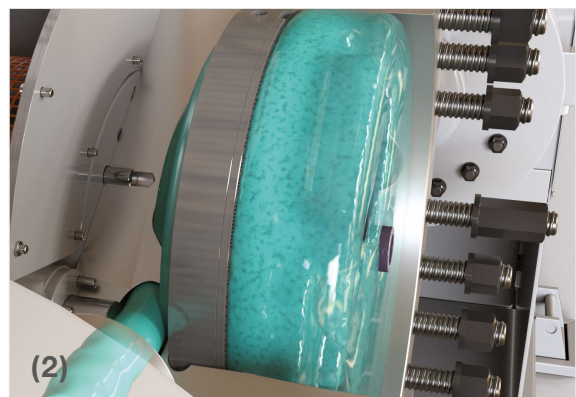

(3) The filtered and purified material exits the **ONE** screen changer for further processing.

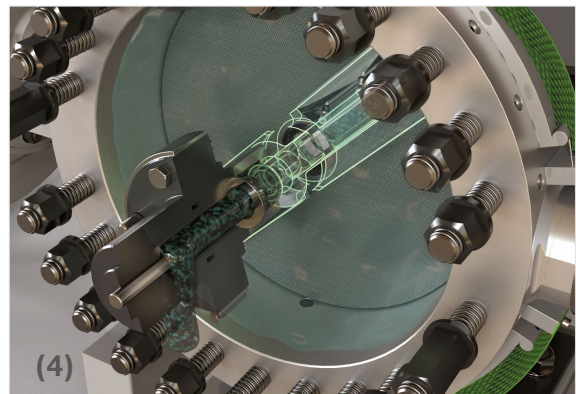

(4) All impurities are collected inside the scraper and automatically expelled through the discharge valve.

Technical characteristics

■ Filtering surfaces

The filtering surfaces guarantee the management of pressure variations with precision, in order to avoid alteration of the flow of the plastic material.

■ Stability

The process stability is ensured by the latest generation of automatic control of the screen changer.

■ Waste Management

The waste material is easily handled, with automatic cut and deposit on the ground or with a special emptying container.

■ Simplicity of use

The simplicity and solidity constructive make the system optimal for operator safety during routine maintenance operations.

AUTOMATIC CONTINUOUS SELF-CLEANING FILTER SCRAPING / BACK FLUSHING

	ONE 400	ONE 500	ONE 600	ONE 700
Screen diameter (mm)	Ø 400	Ø 500	Ø 600	Ø 700
Surface (cm ²)	1206	1916	2783	3807
Laser screen	micron: from 60 to 300 mesh: from 230 to 50			
Punched screen	micron: from 400 to 2000 mesh: from 40 to 10			
Wire screen	back flushing: micron: from 60 to 2000 mesh: from 230 to 10			
Filtered materials	PP / LDPE / LLDPE / HDPE PS / EPS / XPS / ABS / TPU			



Laser Screen



Punched Screen



Wire Screen

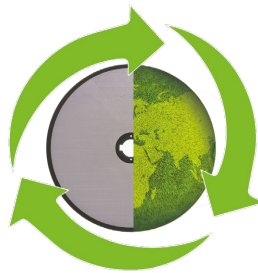

**Environmental sustainability
is always at the core of our vision.**

BREAK MACHINERY s.r.l.

Via Martiri della Libertà, 7
35010 Grantorto (PD) Italy
Tel +39 049 9490350
info@breakmachinery.com
www.breakmachinery.com